

Project:	Type:
Prepared By:	Date:

Lamp Info		Ballast Info	
Type:	ED17	Type:	HX-HPF QT
Watts:	50W	120V:	.6/.6A
Shape/Size:	N/A	208V:	N/A
Base:	N/A	240V:	N/A
ANSI:	N/A	277V:	N/A
Hours:	10,000	Input Watts:	68W
Lamp Lumens:	3,400	Efficiency:	74%
Efficacy:	50 LPW		

Medium size ceiling mount fixture: 35, 50 and 70 Watt HPS, 50 and 70 Watt Metal Halide. Housing is die cast aluminum with clear vandalproof polycarbonate refractor. Quartz Restrike models available. Lamps supplied.

Color: N/A

Weight: 13.7 lbs

Technical Specifications

Listings

UL Listing:

Suitable for wet locations. Fixtures can be wired with 90°C supply wiring if supply wires are routed 3" away from ballast.

EISA 2007 Compliant:

This product complies with the new law for metal halide ballast efficiency. This law goes into effect January 1st, 2008. Pulse Start offers Longer Lamp Life, Faster Startup and Faster Restrike.

Electrical

Sockets:

Medium base 4kv Pulse Rated Glazed porcelain.

HID Quartz restrike:

Add suffix "/QR" to Van3 (50w restrike) or Van5 (100w restrike) for HOT restrike. Provides immediate illumination in case of momentary power failure.

Quad Tap:

Fixture works with 120, 208, 240, and 277 volts.

Photocell:

Button Photocell 120V included. Photocell is only compatible with 120V.

Optical

Refractor:

Injection molded polycarbonate, designed for maximum structural strength.

Construction

Housings:

Die cast aluminum with powder coat bronze or white finish.

Screws:

Tamperproof center pin Torx-head and slotted Phillips head stainless steel screws provided. Be sure to order your Torx screwdriver (Catalog # VANDRIVER).

Reflectors / Backplate:

Heavy gauge cold rolled steel with high reflectance baked white enamel.

Conduit Entry:

1/2".

Other

Country of Origin:

Designed by RAB in New Jersey and assembled in the USA by RAB's IBEW Local 3 workers.

Buy American Act Compliant:

This product is a COTS item manufactured in the United States, and is compliant with the Buy American Act.

Recovery Act (ARRA) Compliant:

This product complies with the 52.225-21 "Required Use of American Iron, Steel, and Manufactured Goods-- Buy American Act-- Construction Materials (October 2010).

Trade Agreements Act Compliant:

This product is a COTS item manufactured in the United States, and is compliant with the Trade Agreements Act.

GSA Schedule:

Suitable in accordance with FAR Subpart 25.4.

Dimensions

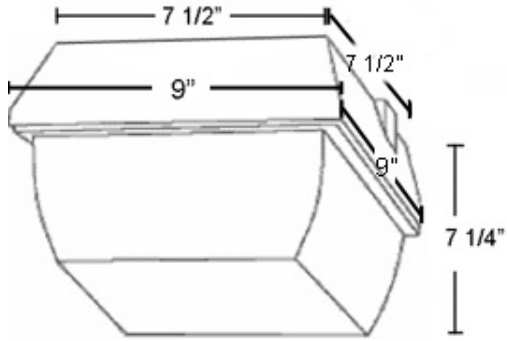

Features

- Both Vandal proof Center Pin Torx and slotted Phillips head screws supplied
- Tough polycarbonate refractors
- Die cast aluminum housing
- Quartz Restrike available, consult factory