



Low-profile vandal-resistant fixture covers the footprint of most traditional canopy lights. Available in flat or drop lens with frosted and unfrosted options.

Color: White

Weight: 11.8 lbs

Project:

Type:

Prepared By:

Date:

Driver Info

Type:	Constant Current
120V:	N/A
208V:	N/A
240V:	N/A
277V:	N/A
Input Watts:	82W
Efficiency:	90%

LED Info

Watts:	75W
Color Temp:	4000K
Color Accuracy:	78 CRI
L70 Lifespan:	100000
Lumens:	7942
Efficacy:	96 LPW

Technical Specifications

Listings

UL Listing:

Suitable for wet locations.

IESNA LM-79 & LM-80 Testing:

RAB LED luminaires have been tested by an independent laboratory in accordance with IESNA LM-79 and LM-80, and have received the Department of Energy "Lighting Facts" label.

Electrical

Drivers:

Class 2, Constant Current, 200-480V, 1980mA, 50-60Hz, <20% THD, >0.93pF, 0-10V Dimming to 10%

THD:

14.3% at 480V

Power Factor:

88.9% at 480V

Dimming Driver:

Driver includes dimming control wiring for 0-10V dimming systems. Requires separate 0-10V DC dimming circuit. Dims as low as 10%.

Construction

Maximum Ambient Temperature:

Suitable for use in 104° F (40°C) ambient temperatures

Cold Weather Starting:

Minimum starting temperature is -40° F (-40° C)

Housing:

Die-cast aluminum housing and lens frame with (4) 1/2" NPS side conduit entries and weatherproof rear wire plug and access plate

Mounting:

Ceiling mount to recessed junction with knockout template or directly to ceiling surface, utilizing side conduit entry points.

IP Rating:

Ingress Protection rating of IP66 for dust and water

Lens:

Vandal-resistant polycarbonate textured opaque for low glare flat lens

Reflector:

Semi-specular, vacuum-metalized polycarbonate

Gaskets:

High-temperature silicone gaskets

Finish:

Our environmentally friendly polyester powder coatings are formulated for high-durability and long-lasting color, and contain no VOC or toxic heavy metals.

Green Technology:

Mercury and UV free. RoHS compliant components. Polyester powder coat finish formulated without the use of VOC or toxic heavy metals.

LED Characteristics

LEDs:

Discreet LEDs on PCB board

Color Stability:

RAB LEDs exceed industry standards for chromatic stability.

Color Uniformity:

RAB's range of CCT (Correlated Color Temperature) follows the guidelines of the American National Standard for Specifications for the Chromaticity of Solid State Lighting (SSL) Products, ANSI C78.377-2015.

Replacement:

Replaces up to 200W Metal Halide.

Other

Warranty:

RAB warrants that our LED products will be free from defects in materials and workmanship for a period of five (5) years from the date of delivery to the end user, including coverage of light output, color stability, driver performance and fixture finish. See our full warranty

Country of Origin:

Designed by RAB in New Jersey and assembled in the USA by RAB's IBEW Local 3 workers.

Buy American Act Compliant:

This product is a COTS item manufactured in the United States, and is compliant with the Buy American Act.

Recovery Act (ARRA) Compliant:

This product complies with the 52.225-21 "Required Use of American Iron, Steel, and Manufactured Goods-- Buy American Act-- Construction Materials (October 2010).

Trade Agreements Act Compliant:

This product is a COTS item manufactured in the United States, and is compliant with the Trade Agreements Act.

GSA Schedule:

Suitable in accordance with FAR Subpart 25.4.

VANLED75NFFRW/480/D10



Dimensions

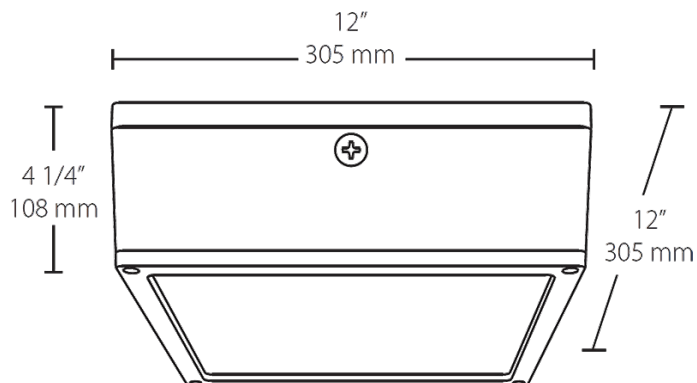

Features

- Fits the footprint of older canopy lights
- Vandal resistant and UV resistant lens
- Ultra-high efficiency
- Clean, contemporary, low-profile design
- Available with drop lens or flat lens
- IP66 rated, keeps dust, bugs and water out
- Photo and motion sensor options available

Ordering Matrix

Family	Watts	Color Temp	Lens	Motion Sensor & Finish	Driver Options	Photocell Options
D10						
	10 = 10W	Blank = 5000K (Cool)	Blank = Drop lens	Blank = Bronze, no sensor W = White, no sensor	Blank = On/Off driver /D10 = 0-10V Dimming (not available for 10w)	/PCS = 120V Swivel
	20 = 20W	N = 4000K (Neutral)	F = Flat lens FR = Frosted Drop Lens	MS = Bronze w/ SMS500 mini-sensor (not available w/ D10 models)	/480 = 480V (not available for 10W or 20W)	/PCS2 = 277V Swivel
	40 = 40W	Y = 3000K (Warm)	FFR = Frosted Flat Lens	MSW = White w/ SMS500 mini-sensor (not available w/ D10 models)	/480/D10 = 480V w/ 0-10V dimming (not available for 10W or 20W)	/PCS4 = 480V Swivel
	52 = 52W					
	65 = 65W					
	75 = 75W					