



High performance 26W LED Vaporproof fixture. A classic design with cutting edge LED technology. Comes with die cast guard and frosted globe.

Color: Natural

Weight: 5.0 lbs

**Project:**

**Type:**

**Prepared By:**

**Date:**

### Driver Info

Type: Constant Current  
 120V: 0.25A  
 208V: 0.14A  
 240V: 0.13A  
 277V: 0.11A  
 Input Watts: 26W  
 Efficiency: 99%

### LED Info

Watts: 26W  
 Color Temp: 3000K  
 Color Accuracy: 81 CRI  
 L70 Lifespan: 100000  
 Lumens: 1,401  
 Efficacy: 53 LPW

## Technical Specifications

### Listings

#### UL Listing:

Suitable for wet locations as downlight.

#### IESNA LM-79 & LM-80 Testing:

RAB LED luminaires have been tested by an independent laboratory in accordance with IESNA LM-79 and LM-80, and have received the Department of Energy "Lighting Facts" label.

### LED Characteristics

#### Lifespan:

100,000-hour LED lifespan based on IES LM-80 results and TM-21 calculations.

#### LED:

Multi-chip 26W high-output, long-life LED.

#### Color Temperature:

3000K

#### Color Consistency:

3-step MacAdam Ellipse binning to achieve consistent fixture-to-fixture color.

#### Color Stability:

LED color temperature is warrantied to shift no more than 200K in CCT over a 5 year period.

#### Color Uniformity:

RAB's range of CCT (Correlated Color Temperature) follows the guidelines of the American National Standard for Specifications for the Chromaticity of Solid State Lighting (SSL) Products, ANSI C38.377-2011.

### Construction

#### Globes and Guards:

Vaporproof LEDs are compatible with RAB Globes and Guards.

#### Cold Weather Starting:

Minimum starting temperature is -40°F / -40°C

#### Ambient Temperature:

Suitable for use in 40°C (104°F) ambient temps.

#### Housing:

All die-cast aluminum construction.

#### Gaskets:

High temperature silicone.

#### Finish:

Natural shot blasted aluminum.

#### Mounting:

Three 3/4" NPS conduit entry points.

#### Guard and Globe:

Shot blasted guard with frosted globe.

#### Green Technology:

Mercury and UV free. RoHS compliant components. Polyester powder coat finish formulated without the use of VOC or toxic heavy metals.

### Electrical

#### Driver:

Constant Current, 100V-277V, 50/60 Hz, 0.48 Amp, Power Factor 97.9%.

### Other

#### Thermal Management (Patent Pending):

Die-cast LED housing designed for maximum heat dissipation.

#### California Title 24:

LVAPOR complies with California Title 24 building and electrical codes.

#### Patents:

The design of the LVAPOR is protected by the following patents US pat. pending; D651738 CN ZL201230040341.3; ZL201130028360.X, TW pat. 101301367 MX 35699; pat. pending CA.

#### Country of Origin:

Designed by RAB in New Jersey and assembled in the USA by RAB's IBEW Local 3 workers.

#### Buy American Act Compliant:

This product is a COTS item manufactured in the United States, and is compliant with the Buy American Act.

#### Recovery Act (ARRA) Compliant:

This product complies with the 52.225-21 "Required Use of American Iron, Steel, and Manufactured Goods-- Buy American Act-- Construction Materials (October 2010).

#### Trade Agreements Act Compliant:

This product is a COTS item manufactured in the United States, and is compliant with the Trade Agreements Act.

#### GSA Schedule:

Suitable in accordance with FAR Subpart 25.4.

## Technical Specifications (continued)

### Other

#### Warranty:

RAB warrants that our LED products will be free from defects in materials and workmanship for a period of five (5) years from the date of delivery to the end user, including coverage of light output, color stability, driver performance and fixture finish.

### Dimensions

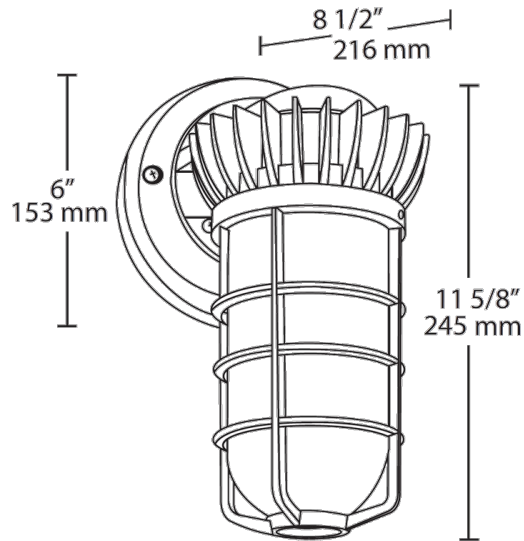

### Features

- Superior Thermal Management (Patent Pending)
- All Die-Cast Aluminum Construction
- 100,000 hour life based on LM-80 tests
- Thermal Shock-Resistant Frosted Glass Globe
- Traditional Look, Cutting-Edge Technology
- 5-year LED warranty