

Project:	Type:
Prepared By:	Date:

Driver Info		LED Info	
Type	Constant Current	Watts	8.00W
120V	0.101A	Color Temp	4000K (Neutral)
208V	N/A	Color Accuracy	80 CRI
240V	N/A	L70 Lifespan	50,000
277V	N/A	Lumens	550
Input Watts	8.00W	Efficacy	68.8 LPW
Efficiency	N/A		

Technical Specifications

Listings

UL Listed:

Suitable for wet locations

ENERGY STAR V2.2:

This product is ENERGY STAR® Version 2.2 Certified.

Energy Star Model Number:

DLW0004

NEC Compliant:

Suitable for use in closets. Compliant with NEC Sec. 410.16 (A)(1) and 410.16 (C)(3).

Electrical

Dimming Driver:

TRIAC compatible dimmer with dimming as low as 5%. [See dimmer compatibility guide here.](#)

Remote Driver:

Die-cast metal driver / junction box with a hinged cover. Listed for 12AWG and 14AWG conduit. Includes two metal knockouts for wiring. Quick connectors included.

PF:

≥0.9

Input Voltage:

120V

Operating Frequency (Hz):

60Hz

LED Characteristics

Lifespan:

50,000-hour LED lifespan based on IES LM-80 results and TM-21 calculations

LEDs:

Long-life, high-efficacy, surface-mount LEDs

Wattage Equivalency:

60W Incandescent

Construction

IC Rated:

Suitable for direct contact with insulation

Air Tight:

Housing certified Air Tight as per ASTM E283

Edgelit Design:

Allows for extremely thin fixture depth for any ceiling application

Trim Style:

Smooth Trim

Housing:

Made from precision die-cast aluminum construction, dissipates heat from electrical components

Cold Weather Starting:

The minimum starting temperature is -30°C (-22°F)

Maximum Ambient Temperature:

Suitable for use in 40°C (104°F)

Lens:

Frosted polycarbonate diffusion lens

Technical Specifications (continued)

Construction

Green Technology:

Mercury and UV free. RoHS-compliant components.

Mounting:

Robust retention clips spring loaded tabs ensure the fixture is securely installed. Can be installed in 1/4" to 1 1/2" thick ceilings.

Finish:

Matte White

Optical

Beam Angle:

120°

Other

Template:

Template included for easy ceiling cut out

Warranty:

RAB warrants that our LED products will be free from defects in materials and workmanship for a period of five (5) years from the date of delivery to the end user, including coverage of light output, color stability, driver performance and fixture finish. RAB's warranty is subject to all terms and conditions found at rablighting.com/warranty.

Buy American Act Compliance:

RAB values USA manufacturing! Upon request, RAB may be able to manufacture this product to be compliant with the Buy American Act (BAA). Please contact customer service to request a quote for the product to be made BAA compliant.

Minimum Compartment Size

Length x Width x Height [in]	Lamp Quantity
6.0 x 6.0 x 8.5	1

Case and Pallet Dimensions

	QTY	LENGTH	WIDTH	HEIGHT
CASE	6	9.29	7.91	6.54
PALLET	1350	4.29	2.36	58.82

Dimension

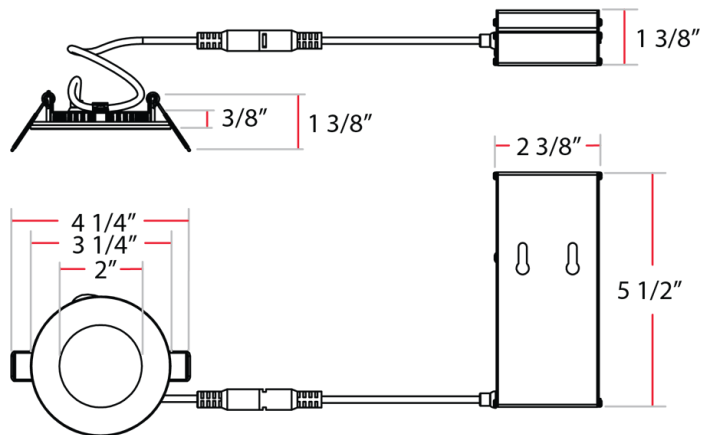

Features

- Super slim Edge-lit fixture for thin fixture depth
- No recessed housing or J-box required
- New construction or retrofit applications
- UL wet location rated
- Smooth diffused uniform light distribution
- Dimmable down to 5% on compatible dimmers
- Spring loaded retention clips
- Robust, die cast aluminum construction
- IC and airtight rated
- 5-Year, No-Compromise Warranty

Ordering Matrix

Family	Size	Shape	Wattage	CRI/Color Temp	Voltage	Finish	Trim
WFR	3	R	8	840	120	W	S
	3 = 3" 4 = 4" 6 = 6" 8 = 8"	R = Round	8 = 550lm 9 = 550lm 12 = 750lm-900lm 14 = 950lm 15 = 1150lm 24 = 1900lm	940 = 90 CRI, 4000K (Neutral) 935 = 90 CRI, 3500K (Warm Neutral) 930 = 90 CRI, 3000K (Warm) 927 = 90 CRI, 2700K (Residential Warm) 840 = 80 CRI, 4000K (Neutral) 835 = 80 CRI, 3500K (Warm Neutral) 830 = 80 CRI, 3000K (Warm) 827 = 80 CRI, 2700K (Residential Warm)	120 = 120V (Phase Dimming) UNV = 120-277V (0-10V Dimming)	W = White	B = Baffle S = Smooth