



LED 104W Wallpacks. 3 cutoff options. Patent Pending thermal management system. 100,000 hour L70 lifespan. 5 Year Warranty. Includes built in support for Lightcloud, a wireless lighting control system and service, fully developed by RAB.

Color: White

Weight: 26.0 lbs

<b>Project:</b>	<b>Type:</b>
<b>Prepared By:</b>	<b>Date:</b>

Driver Info		LED Info	
Type:	Constant Current	Watts:	104W
120V:	0.95A	Color Temp:	4000K
208V:	0.59A	Color Accuracy:	82 CRI
240V:	0.51A	L70 Lifespan:	100000
277V:	0.44A	Lumens:	9,823
Input Watts:	107W	Efficacy:	92 LPW
Efficiency:	97%		

## Technical Specifications

### Lightcloud

#### Lightcloud Installed:

Lightcloud is a commercial wireless lighting control system and service fully developed and supported by RAB. It's powerful and flexible, yet easy to use and install.

### Listings

#### UL Listing:

UL Suitable for Wet Locations as Uplight and Downlight Wall Mount Only.

#### IESNA LM-79 & LM-80 Testing:

RAB LED Luminaires have been tested by an independent laboratory in accordance with IESNA LM-79 and LM-80, and have received the Department of Energy "Lighting Facts" label.

#### DLC Listed:

This product is on the Design Lights Consortium (DLC) Qualified Products List and is eligible for rebates from DLC Member Utilities.  
DLC Product Code: P000017B4

### Construction

#### IP Rating:

Ingress Protection rating of IP66 for dust and water.

#### Cold Weather Starting:

Minimum starting temperature is -40°F / -40°C

#### Maximum Ambient Temperature:

Suitable for use in 40°C (104°F) ambient temperatures

#### Thermal Management:

Superior thermal management with external Air-Flow fins.

#### Housing:

Precision die-cast aluminum housing, door frame arm and wall bracket.

#### Mounting:

Die-cast aluminum wall bracket with (5) 1/2" conduit openings with plugs. Two-piece bracket with tether for ease of installation and wiring.

#### Arm:

Die-cast aluminum with wiring access plate.

#### Cutoff:

Standard (15°)

#### Lens:

Tempered glass.

#### Reflector:

Specular vacuum metallized polycarbonate.

#### Gaskets:

High-temperature silicone

#### Finish:

Our environmentally friendly polyester powder coatings are formulated for high-durability and long-lasting color, and contains no VOC or toxic heavy metals.

#### Green Technology:

Mercury and UV free. RoHS compliant components. Polyester powder coat finish formulated without the use of VOC or toxic heavy metals.

### LED Characteristics

#### LEDs:

Four multi-chip, high-output, long-life LEDs.

#### Lifespan:

100,000-hour LED lifespan based on IES LM-80 results and TM-21 calculations.

#### Color Consistency:

3-step MacAdam Ellipse binning to achieve consistent fixture-to-fixture color.

#### Color Stability:

LED color temperature is warrantied to shift no more than 200K in CCT over a 5 year period.

#### Color Uniformity:

RAB's range of CCT (Correlated Color Temperature) follows the guidelines of the American National Standard for Specifications for the Chromaticity of Solid State Lighting (SSL) Products, ANSI C78.377.2011.

### Electrical

#### Driver:

Constant current, Class 1, 100-277V, 50/60 Hz, 4kV Surge Protection, 700mA, 100-277V = 0.95A, Power Factor 99.4%.

#### THD:

4.5% at 120V, 8.8% at 277V

### Other

#### Equivalency:

The WPLED104 is Equivalent in delivered lumens to a 400W Metal Halide Wallpack.

#### California Title 24:

See WPLED104/BL for a 2013 California Title 24 compliant product. Any additional component requirements will be listed in the Title 24 section under technical specifications on the product page.

## Technical Specifications (continued)

### Other

#### Patents:

The design of the WPLED104 is protected by patents pending in US, Canada, China, Taiwan and Mexico.

#### Warranty:

RAB warrants that our LED products will be free from defects in materials and workmanship for a period of five (5) years from the date of delivery to the end user, including coverage of light output, color stability, driver performance and fixture finish.

#### Buy American Act Compliant:

This product is a COTS item manufactured in the United States, and is compliant with the Buy American Act.

#### Recovery Act (ARRA) Compliant:

This product complies with the 52.225-21 "Required Use of American Iron, Steel, and Manufactured Goods-- Buy American Act-- Construction Materials (October 2010).

#### Trade Agreements Act Compliant:

This product is a COTS item manufactured in the United States, and is compliant with the Trade Agreements Act.

#### GSA Schedule:

Suitable in accordance with FAR Subpart 25.4.

### Optical

#### BUG Rating:

B1 U1 G3

## Dimensions

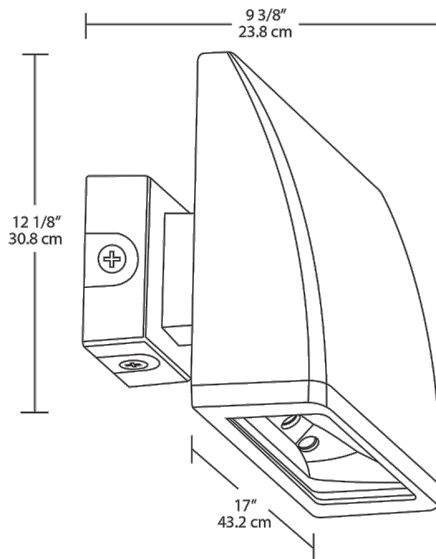

## Features

- High performance LED light engine
- Maintains 70% of initial lumens at 100,000 hours
- Weatherproof high temperature silicone gaskets
- Superior heat sinking with die cast aluminum housing and external fins
- Replaces 400W MH
- 100 up to 277 Volts
- 5-year warranty
- Built in support Lightcloud™
- Easy setup - simply power on, confirm device connectivity and call 844-LIGHTCLOUD