



Ultra high output, high efficiency 50 Watt LED wallpacks. Patent Pending airflow technology ensures long LED and driver lifespan. 5 Year Warranty.

Color: Bronze

Weight: 34.8 lbs

Project:

Type:

Prepared By:

Date:

Driver Info

Type:	Constant Current
120V:	N/A
208V:	0.27A
240V:	0.23A
277V:	0.20A
Input Watts:	52W
Efficiency:	97%

LED Info

Watts:	50W
Color Temp:	5000K
Color Accuracy:	67 CRI
L70 Lifespan:	100000
Lumens:	4,846
Efficacy:	94 LPW

Technical Specifications

Electrical

Photocell:

277V Swivel Photocell Included. Photocell is compatible with 208V-277V.

Driver:

Constant Current, Class 2, 1400mA, 100-277V, 50-60Hz, 0.8A, Power Factor 99%

THD:

7.0% at 120V, 7.4% at 277V

Surge Protection:

6kV surge suppression protection tested in accordance with IEEE/ANSI C62.41.2.

Listings

UL Listing:

Suitable for wet locations as a downlight.

IESNA LM-79 & IESNA LM-80 Testing:

RAB LED fixtures have been tested by an independent laboratory in accordance with IESNA LM-79 and 80, and have received the Department of Energy "Lighting Facts" label.

Dark Sky Approved:

The International Dark Sky Association has approved this product as a full cutoff, fully shielded luminaire.

DLC Listed:

This product is on the Design Lights Consortium (DLC) Qualified Products List and is eligible for rebates from DLC Member Utilities.
DLC Product Code: P00001794

LED Characteristics

Lifespan:

100,000-hour LED lifespan based on IES LM-80 results and TM-21 calculations.

LEDs:

Multi-chip, high-output, long-life LEDs

Color Consistency:

7-step MacAdam Ellipse binning to achieve consistent fixture-to-fixture color.

Color Stability:

LED color temperature is warranted to shift no more than 200K in CCT over a 5 year period.

Color Uniformity:

RAB's range of CCT (Correlated Color Temperature) follows the guidelines of the American National Standard for Specifications for the Chromaticity of Solid State Lighting (SSL) Products, ANSI C78.377-2011.

Construction

IES Classification:

The Type III distribution is ideal for roadway, general parking and other area lighting applications where a larger pool of lighting is required. It is intended to be located near the side of the area, allowing the light to project outward and fill the area.

IP Rating:

Ingress Protection rating of IP66 for dust and water.

Ambient Temperature:

Suitable for use in 40°C ambient temperatures.

Cold Weather Starting:

The minimum starting temperature is -40°C/-40°F

Thermal Management:

Superior patent pending thermal management design with external Air-Flow fins provides maximum operational life, even in high ambient temperature environments.

Housing:

Die cast aluminum housing, lens frame and mounting arm.

Mounting:

Heavy-duty mounting arm with "O" ring seal & stainless steel screws.

Reflector:

Specular vacuum-metallized polycarbonate

Gaskets:

High temperature silicone gaskets

Finish:

Our environmentally friendly polyester powder coatings are formulated for high-durability and long-lasting color, and contains no VOC or toxic heavy metals.

Green Technology:

Mercury and UV free. RoHS compliant components. Polyester powder coat finish formulated without the use of VOC or toxic heavy metals.

Other

Equivalency:

WPLED™ 50W replaces 200W metal halide

California Title 24:

WPLED50 with available photocell option complies with 2013 California Title 24 building and electrical codes as a commercial outdoor pole-mounted fixture ≤ 75 Watts. Add /PCT to include a photocell.

Technical Specifications (continued)

Other

Patents:

The WPLED™ design is protected by patents pending in the U.S., Canada, China, Taiwan and Mexico.

Warranty:

RAB warrants that our LED products will be free from defects in materials and workmanship for a period of five (5) years from the date of delivery to the end user, including coverage of light output, color stability, driver performance and fixture finish.

Country of Origin:

Designed by RAB in New Jersey and assembled in the USA by RAB's IBEW Local 3 workers.

Buy American Act Compliant:

This product is a COTS item manufactured in the United States, and is compliant with the Buy American Act.

Recovery Act (ARRA) Compliant:

This product complies with the 52.225-21 "Required Use of American Iron, Steel, and Manufactured Goods-- Buy American Act-- Construction Materials (October 2010).

Trade Agreements Act Compliant:

This product is a COTS item manufactured in the United States, and is compliant with the Trade Agreements Act.

GSA Schedule:

Suitable in accordance with FAR Subpart 25.4.

Optical

BUG Rating:

B1 U0 G2

Dimensions

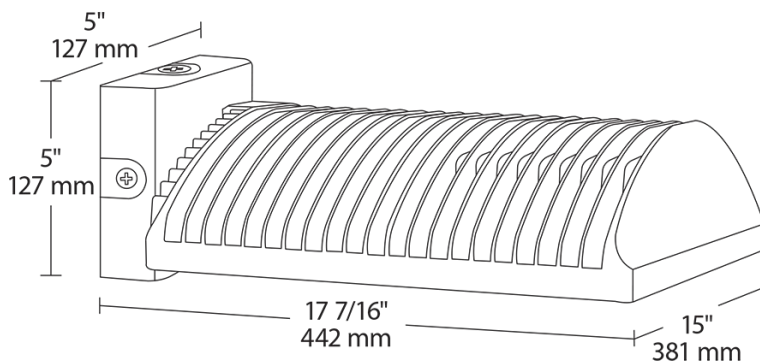

Features

- High output, high efficiency LED
- Maintains 70% of initial lumens at 100,000 hours
- Weatherproof high temperature silicone gaskets
- Superior heat sinking with die cast aluminum housing and external fins
- 100 up to 277 Volts
- 5-year warranty

Ordering Matrix

Family	Distribution	Watts	Color Temp	Mount	Finish	Voltage	Photocell	Dimming	Sensor	Bi-Level
WPLED										
	2T = Type II 3T = Type III 4T = Type IV	50 = 50W	Blank = 5000K (Cool) Y = 3000K (Warm) N = 4000K (Neutral)	Blank = Standard FX = Flat Wall	Blank = Bronze W = White	Blank = 120-277V /480 = 480V	Blank = No Photocell /PC = 120V Button /PC2 = 277 Button /PCS = 120V Swivel /PCS2 = 277V Swivel /PCT = 120-277V Twistlock /PCS4 = 480V Swivel /PCT4 = 480V Twistlock	Blank = No Dimming /D10 = Dimmable	/WS2 = Multi-Level Motion Sensor (Only available for 120-277V with /D10 for 50W)	Blank = No Bi-Level /BL = Bi-Level