



Ultra high output, high efficiency 260 Watt LED wallpacks. Patent Pending airflow technology ensures long LED and driver lifespan. 5 Year Warranty.

Color: Bronze

Weight: 73.4 lbs

**Project:**

**Type:**

**Prepared By:**

**Date:**

### Driver Info

Type: Constant Current  
 120V: 2.2A  
 208V: 1.3A  
 240V: 1.1A  
 277V: 1.0A  
 Input Watts: 263W  
 Efficiency: 99%

### LED Info

Watts: 260W  
 Color Temp: 5000K  
 Color Accuracy: 70 CRI  
 L70 Lifespan: 100000  
 Lumens: 27,428  
 Efficacy: 104 LPW

## Technical Specifications

### Listings

#### UL Listing:

Suitable for wet locations.

#### DLC Listed:

This product is on the Design Lights Consortium (DLC) Qualified Products List and is eligible for rebates from DLC Member Utilities.

#### IESNA LM-79 & IESNA LM-80 Testing:

RAB LED luminaires have been tested by an independent laboratory in accordance with IESNA LM-79 and 80, and have received the Department of Energy "Lighting Facts" label.

#### Dark Sky Approved:

The International Dark Sky Association has approved this product as a full cutoff, fully shielded luminaire.

### Construction

#### IP Rating:

Ingress Protection rating of IP66 for dust and water.

#### IES Classification:

The Type IV distribution (also known as a Forward Throw) is especially suited for mounting on the sides of buildings and walls, and for illuminating the perimeter of parking areas. It produces a semiCircular distribution with essentially the same candlepower at lateral angles from 90° to 270°.

#### Maximum Ambient Temperature:

Suitable for use in 40°C (104°F) ambient temperatures

#### Cold Weather Starting:

The minimum starting temperature is -40°C/-40°F

#### Thermal Management:

Superior heat sinking with external Air-Flow fins.

#### Housing:

Die cast aluminum with airflow fins for cooling.

#### Lens:

Tempered glass

#### Reflector:

Vacuum-metalized polycarbonate

#### Gaskets:

High temperature silicone gaskets.

#### Finish:

Our environmentally friendly polyester powder coatings are formulated for high-durability and long-lasting color, and contains no VOC or toxic heavy metals.

#### Green Technology:

Mercury and UV free. RoHS compliant components. Polyester powder coat finish formulated without the use of VOC or toxic heavy metals.

#### For use on LEED Buildings:

IDA Dark Sky Approval means that this fixture can be used to achieve LEED Credits for Light Pollution Reduction.

### LED Characteristics

#### LEDs:

Multi-chip, high-output, long-life LEDs

#### Color Consistency:

3-step MacAdam Ellipse binning to achieve consistent fixture-to-fixture color.

#### Color Stability:

LED color temperature is warrantied to shift no more than 200K in CCT over a 5 year period.

#### Color Uniformity:

RAB's range of CCT (Correlated Color Temperature) follows the guidelines of the American National Standard for Specifications for the Chromaticity of Solid State Lighting (SSL) Products, ANSI C78.377-2011.

### Electrical

#### Dimming Driver:

Driver includes dimming control wiring for 0-10V dimming systems. Requires separate 0-10V DC dimming circuit. Dims as low as 10%.

#### Drivers:

Constant Current, Class 1, 1660mA, 100-277V, 50-60Hz, 120V: 2.2A, 208V: 1.3A, 240V: 1.1A, 277V: 1.0A

#### Surge Protection:

6kV

### Other

#### Country of Origin:

Designed by RAB in New Jersey and assembled in the USA by RAB's IBEW Local 3 workers.

#### Buy American Act Compliant:

This product is a COTS item manufactured in the United States, and is compliant with the Buy American Act.

#### Recovery Act (ARRA) Compliant:

This product complies with the 52.225-21 "Required Use of American Iron, Steel, and Manufactured Goods-- Buy American Act-- Construction Materials (October 2010).

## Technical Specifications (continued)

### Other

#### Trade Agreements Act Compliant:

This product is a COTS item manufactured in the United States, and is compliant with the Trade Agreements Act.

#### GSA Schedule:

Suitable in accordance with FAR Subpart 25.4.

### Warranty:

RAB warrants that our LED products will be free from defects in materials and workmanship for a period of five (5) years from the date of delivery to the end user, including coverage of light output, color stability, driver performance and fixture finish.

### Patents:

The WPLED design is protected by patents pending in the U.S., Canada, China, Taiwan and Mexico.

## Dimensions

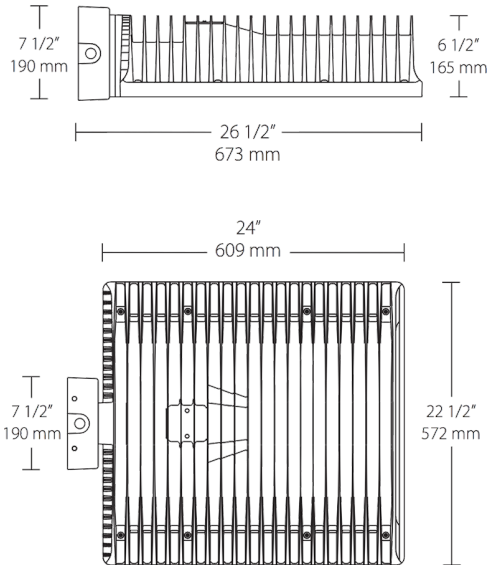

## Features

High output, high efficiency LED

Maintains 70% of initial lumens at 100,000 hours

Weatherproof high temperature silicone gaskets

Superior heat sinking with die cast aluminum housing and external fins

5-year warranty