



Ultra high output, high efficiency 260 Watt LED wallpacks. Patent Pending airflow technology ensures long LED and driver lifespan. 5 Year Warranty.

Color: White

Weight: 79.4 lbs

Project:	Type:
Prepared By:	Date:

Driver Info		LED Info	
Type:	Constant Current	Watts:	260W
120V:	N/A	Color Temp:	3000K
208V:	N/A	Color Accuracy:	70 CRI
240V:	N/A	L70 Lifespan:	100000
277V:	N/A	Lumens:	26,728
Input Watts:	253W	Efficacy:	106 LPW
Efficiency:	N/A		

Technical Specifications

Listings

UL Listing:

Suitable for wet locations.

DLC Listed:

This product is on the Design Lights Consortium (DLC) Qualified Products List and is eligible for rebates from DLC Member Utilities.

IESNA LM-79 & IESNA LM-80 Testing:

RAB LED luminaires have been tested by an independent laboratory in accordance with IESNA LM-79 and 80, and have received the Department of Energy "Lighting Facts" label.

Dark Sky Approved:

The International Dark Sky Association has approved this product as a full cutoff, fully shielded luminaire.

Construction

IP Rating:

Ingress Protection rating of IP66 for dust and water.

IES Classification:

The Type IV distribution (also known as a Forward Throw) is especially suited for mounting on the sides of buildings and walls, and for illuminating the perimeter of parking areas. It produces a semiCircular distribution with essentially the same candlepower at lateral angles from 90° to 270°.

Maximum Ambient Temperature:

Suitable for use in 40°C (104°F) ambient temperatures

Cold Weather Starting:

The minimum starting temperature is -40°C/-40°F

Thermal Management:

Superior heat sinking with external Air-Flow fins.

Housing:

Die cast aluminum with airflow fins for cooling.

Lens:

Tempered glass

Reflector:

Vacuum-metalized polycarbonate

Gaskets:

High temperature silicone gaskets.

Finish:

Our environmentally friendly polyester powder coatings are formulated for high-durability and long-lasting color, and contains no VOC or toxic heavy metals.

Green Technology:

Mercury and UV free. RoHS compliant components. Polyester powder coat finish formulated without the use of VOC or toxic heavy metals.

For use on LEED Buildings:

IDA Dark Sky Approval means that this fixture can be used to achieve LEED Credits for Light Pollution Reduction.

LED Characteristics

LEDs:

Multi-chip, high-output, long-life LEDs

Color Consistency:

3-step MacAdam Ellipse binning to achieve consistent fixture-to-fixture color.

Color Stability:

LED color temperature is warrantied to shift no more than 200K in CCT over a 5 year period.

Color Uniformity:

RAB's range of CCT (Correlated Color Temperature) follows the guidelines of the American National Standard for Specifications for the Chromaticity of Solid State Lighting (SSL) Products, ANSI C78.377-2011.

Electrical

Dimming Driver:

Driver includes dimming control wiring for 0-10V dimming systems. Requires separate 0-10V DC dimming circuit. Dims as low as 10%.

Drivers:

Constant Current, Class 1, 1660mA, 480V, 50-60Hz, 480V: xxA.

Surge Protection:

6kV

Other

Country of Origin:

Designed by RAB in New Jersey and assembled in the USA by RAB's IBEW Local 3 workers.

Buy American Act Compliant:

This product is a COTS item manufactured in the United States, and is compliant with the Buy American Act.

Recovery Act (ARRA) Compliant:

This product complies with the 52.225-21 "Required Use of American Iron, Steel, and Manufactured Goods-- Buy American Act-- Construction Materials (October 2010).

Technical Specifications (continued)

Other

Trade Agreements Act Compliant:

This product is a COTS item manufactured in the United States, and is compliant with the Trade Agreements Act.

GSA Schedule:

Suitable in accordance with FAR Subpart 25.4.

Warranty:

RAB warrants that our LED products will be free from defects in materials and workmanship for a period of five (5) years from the date of delivery to the end user, including coverage of light output, color stability, driver performance and fixture finish.

Patents:

The WPLED design is protected by patents pending in the U.S., Canada, China, Taiwan and Mexico.

Dimensions

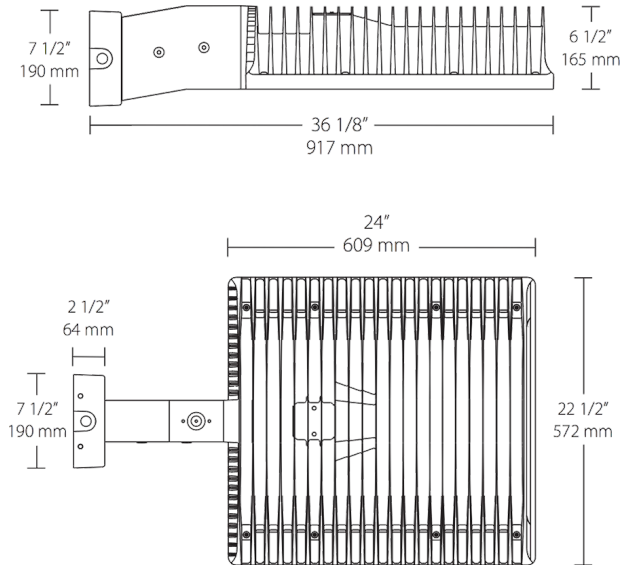

Features

High output, high efficiency LED

Maintains 70% of initial lumens at 100,000 hours

Weatherproof high temperature silicone gaskets

Superior heat sinking with die cast aluminum housing and external fins

5-year warranty