



LED 78W Wallpacks. 3 cutoff options. Patent Pending thermal management system. 100,000 hour L70 lifespan. 5 Year Warranty.

Color: Bronze

Weight: 34.8 lbs

Project:

Type:

Prepared By:

Date:

Driver Info

Type: Constant Current
 120V: N/A
 208V: N/A
 240V: N/A
 277V: N/A
 Input Watts: 79W
 Efficiency: 98%

LED Info

Watts: 78W
 Color Temp: 5100K
 Color Accuracy: 67 CRI
 L70 Lifespan: 100000
 Lumens: 7,443
 Efficacy: 94 LPW

Technical Specifications

Listings

UL Listing:

Suitable for wet locations as a downlight.

IESNA LM-79 & IESNA LM-80 Testing:

RAB LED luminaires have been tested by an independent laboratory in accordance with IESNA LM-79 and 80, and have received the Department of Energy "Lighting Facts" label.

Dark Sky Approved:

The International Dark Sky Association has approved this product as a full cutoff, fully shielded luminaire.

Optical

Lumen Maintenance:

100,000-hour LED lifespan based on IES LM-80 results and TM-21 calculations.

Specification Grade Optics:

The Type IV distribution (also known as a Forward Throw) is especially suited for mounting on the sides of buildings and walls, and for illuminating the perimeter of parking areas. It produces a semiCircular distribution with essentially the same candlepower at lateral angles from 90° to 270°.

Replacement:

The WPLED78 replaces 400W Metal Halide Wallpacks.

BUG Rating:

B1 U0 G2

Construction

IP Rating:

Ingress Protection rating of IP66 for dust and water.

Ambient Temperature:

Suitable for use in 40°C ambient temperatures.

Cold Weather Starting:

The minimum starting temperature is -40°C/-40°F

Thermal Management:

Superior heat sinking with external Air-Flow fins.

Housing:

Die cast aluminum housing, lens frame and mounting arm.

Reflector:

Specular vacuum-metallized polycarbonate

Gaskets:

High temperature silicone gaskets.

Finish:

Our environmentally friendly polyester powder coatings are formulated for high-durability and long-lasting color, and contains no VOC or toxic heavy metals.

Green Technology:

Mercury and UV free. RoHS compliant components. Polyester powder coat finish formulated without the use of VOC or toxic heavy metals.

For use on LEED Buildings:

IDA Dark Sky Approval means that this fixture can be used to achieve LEED Credits for Light Pollution Reduction.

LED Characteristics

LEDs:

Six (6) multi-chip, 13W, high-output, long-life LEDs.

Color Consistency:

3-step MacAdam Ellipse binning to achieve consistent fixture-to-fixture color.

Color Stability:

LED color temperature is warranted to shift no more than 200K in CCT over a 5 year period.

Color Uniformity:

RAB's range of CCT (Correlated Color Temperature) follows the guidelines of the American National Standard for Specifications for the Chromaticity of Solid State Lighting (SSL) Products, ANSI C78.377-2011.

Electrical

Driver:

Constant Current, Class 2, 2000mA, 347-480V, 50-60Hz, 0.17A, Power Factor 96.4%

THD:

9.9% at 480V

Starting/Operating Amps:

480V = 0.17A

Surge Protection:

6kV

Other

California Title 24:

See WPLED4T78/BL for a 2013 California Title 24 compliant product. Any additional component requirements will be listed in the Title 24 section under technical specifications on the product page.

Technical Specifications (continued)

Other

Warranty:

RAB warrants that our LED products will be free from defects in materials and workmanship for a period of five (5) years from the date of delivery to the end user, including coverage of light output, color stability, driver performance and fixture finish.

Patents:

The WPLED design is protected by patents pending in the U.S., Canada, China, Taiwan and Mexico.

Country of Origin:

Designed by RAB in New Jersey and assembled in the USA by RAB's IBEW Local 3 workers.

Buy American Act Compliant:

This product is a COTS item manufactured in the United States, and is compliant with the Buy American Act.

Recovery Act (ARRA) Compliant:

This product complies with the 52.225-21 "Required Use of American Iron, Steel, and Manufactured Goods-- Buy American Act-- Construction Materials (October 2010).

Trade Agreements Act Compliant:

This product is a COTS item manufactured in the United States, and is compliant with the Trade Agreements Act.

GSA Schedule:

Suitable in accordance with FAR Subpart 25.4.

Dimensions

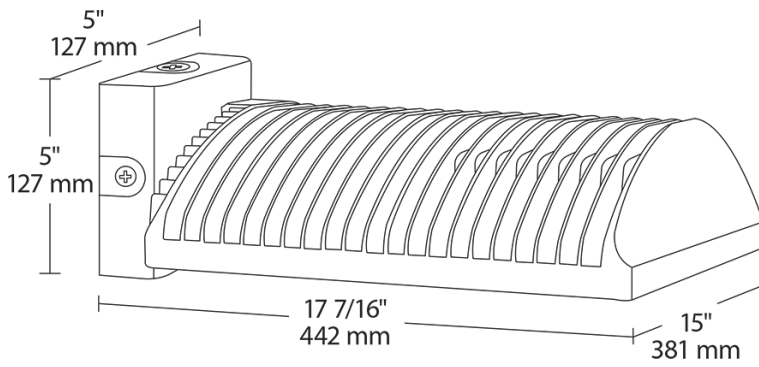

Features

- High performance LED light engine
- Maintains 70% of initial lumens at 100,000 hours
- Weatherproof high temperature silicone gaskets
- Superior heat sinking with die cast aluminum housing and external fins
- Replaces 400W MH
- 100 up to 277 Volts
- 5-year warranty

Ordering Matrix

Family	Distribution	Watts	Color Temp	Mount	Finish	Voltage	Photocell	Dimming	Sensor	Bi-Level
WPLED										
	2T = Type II 3T = Type III 4T = Type IV	78 = 78W	Blank = 5000K (Cool) Y = 3000K (Warm) N = 4000K (Neutral)	Blank = Standard FX = Flat Wall	Blank = Bronze W = White	Blank = 120-277V /480 = 480V	Blank = No Photocell /PC = 120V Button /PC2 = 277 Button /PCS = 120V Swivel /PCS2 = 277V Swivel /PCS4 = 480V Swivel	Blank = No Dimming /D10 = Dimmable	/WS2 = Multi-Level Motion Sensor (Only available for 120-277V with /D10 for 50W)	Blank = No Bi-Level /BL = Bi-Level