



Heavy duty die cast aluminum housing with prismatic glass refractor. HPS and Metal Halide models available with 1/2" bottom and back conduit opening. Factory installed photocell optional. Lamp supplied.

Color: White

Weight: 8.8 lbs

Project:	Type:
Prepared By:	Date:

Lamp Info		Ballast Info	
Type:	ED17	Type:	HX-NPF 120V
Watts:	50W	120V:	2.0/1.6A
Shape/Size:	N/A	208V:	N/A
Base:	N/A	240V:	N/A
ANSI:	N/A	277V:	N/A
Hours:	10,000	Input Watts:	69W
Lamp Lumens:	3,400	Efficiency:	72%
Efficacy:	49 LPW		

Technical Specifications

Listings

UL Listing:

Suitable for wet locations.

EISA 2007 Compliant:

This product complies with the new law for metal halide ballast efficiency. This law goes into effect January 1st, 2008. Pulse Start offers Longer Lamp Life, Faster Startup and Faster Restrike.

Construction

Reflector:

Die formed aluminum for wide light distribution. Moveable Glare Shield for field adjustable light control slanted slightly downward for more light on the job.

Option:

Photocell 277 volt.

Housing:

Heavy duty cast aluminum housing.

Electrical

Ballast Housing:

Stamped steel painted white.

Other

Back Plate:

Heavy die cast aluminum. 1/2" bottom conduit knockout. Knockouts for mounting to 3" or 4" junction boxes.

Patents:

The designs of RAB fixtures are protected under U.S., Canadian and international intellectual property laws.

Buy American Act Compliant:

This product is a COTS item manufactured in the United States, and is compliant with the Buy American Act.

Recovery Act (ARRA) Compliant:

This product complies with the 52.225-21 "Required Use of American Iron, Steel, and Manufactured Goods-- Buy American Act-- Construction Materials (October 2010).

Trade Agreements Act Compliant:

This product is a COTS item manufactured in the United States, and is compliant with the Trade Agreements Act.

GSA Schedule:

Suitable in accordance with FAR Subpart 25.4.

Optical

Reflector:

Heavy prismatic glass refractor.

Dimensions

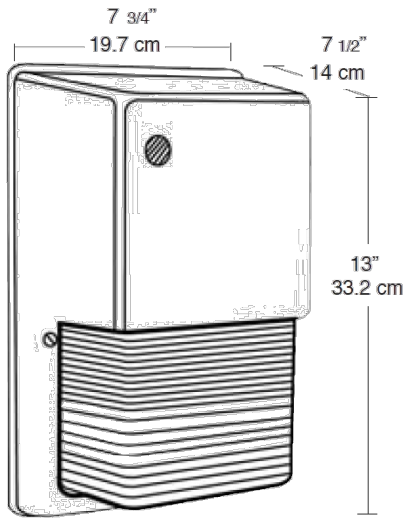

Features

- Heavy, die cast aluminum back plate with box mounting template
- Shades work great with tallpacks!
- 1/2" bottom conduit knockout
- Packaging has product features, ballast and lamp specifications
- Lighting layout photometrics and installation instructions are available